



## Diversified Power International

414 Century Court

Piney Flats, TN 37686

(423) 538-9002 (423) 538-9202 (fax)

www.DPIpower.com

# ACCUSENSE CHARGE SERIES FULLY AUTOMATIC BATTERY CHARGER



### SPECIFICATIONS:

Part Number: 1-36C018CXX-XXXX

Mode-1

Use for US Battery

Mode-2

Use for Trojan T108

Mode-3

Use for Trojan T105

Mode-4

Use for Exide

Input: 120Vac, 10Aac, 60Hz

Output: 36Vdc, 18/16 Adc

Safety Timer: 17 Hours

**IMPORTANT: READ AND SAVE THIS SAFETY  
INSTRUCTION MANUAL.  
KEEP IT WITH OR NEAR CHARGER AT ALL TIMES**

# Table of Contents

<u>Section</u>	<u>Description</u>	<u>Pg</u>	<u>Section</u>	<u>Description</u>	<u>Pg</u>
1	Features	2	7	5-Stage Charge	7
2	Introduction	2	8	L.E.D. Display	9
3	User Safety	3	9	Troubleshooting	9
4	Installation	4	10	Wiring Diagram	12
5	Grounding	5	11	Parts List	12
6	Preparing to Charge	5	12	Warranty	14



Throughout this manual, look for this symbol. It means **BE ALERT – YOUR SAFETY IS INVOLVED**. If you do not follow these safety instructions, personal injury or property damage may occur.

## 1. Features

- Fully Automatic - starts and stops charging automatically
- 5 L.E.D. display to easily interpret charge and/or charge error conditions
- Many safety features, including Reverse Battery Protection and Wrong Battery Connections
- Charge algorithm controls BOTH voltage and current for precise charging
- Microprocessor-based control implements an intelligent charge
- Full, automatic disconnect from AC power after completion of charge
- After completion of charge, charger will monitor battery voltage levels

## 2. Introduction

The Diversified Power International (DPI) battery charger is designed to recharge deep-cycle, lead-acid batteries. It is factory preset to operate in one of 3 different charge modes; refer to Section 6 for further details.

Its simple method of operation and trouble-free performance makes it attractive to use. To operate, after the charger is connected to AC power, simply plug in the DC cord set to activate the unit. The charger then automatically charges the battery, and also monitors the battery condition determining the proper charge profile and the correct finish phase before automatically terminating the charge when the battery is fully charged.

If left connected to the battery and AC power, the charger will disconnect itself from AC power, but continue to actively monitor the battery voltage.

### 3. User Safety Operations Guide



WARNING - RISK OF EXPLOSIVE GASES.

WORKING WITH LEAD-ACID BATTERY IS DANGEROUS. EXPLOSIVE GASES DEVELOP DURING NORMAL BATTERY OPERATION. READ THIS MANUAL EACH TIME AND MAKE CERTAIN YOU FULLY UNDERSTAND IT AND FOLLOW THE SAFETY AND OPERATING INSTRUCTIONS AT ALL TIMES.

- To reduce risk of battery explosion, follow all safety instructions below and those published by the battery manufacturer. Review cautionary markings on vehicle or equipment containing the battery.
- Use of an attachment not recommended or sold by the battery charger manufacturer may result in a risk of fire, electric shock or injury to persons.
- Do not operate this charger if it has received a sharp blow, was dropped or otherwise damaged in any manner. Refer to a qualified service agent.
- Charger contains no serviceable parts. If it fails during its warranty period, contact your dealer for a warranty replacement.
- To reduce risk of electric shock, unplug charger from AC outlet before attempting any maintenance or cleaning.

#### **Personal Precautions While Working With Batteries**

- Have someone within range of your voice to come to your aid if needed.
- Have plenty of fresh water and soap nearby in case battery acid contacts your skin, clothing or eyes. Wear eye and clothing protection and avoid touching eyes.
- If battery acid contacts skin or clothing, wash immediately with soap and water.
- If acid enters eye, immediately flush eye with running cold water for at least 10 minutes. Get medical attention immediately.
- NEVER smoke or allow a spark or flame in vicinity of battery.
- Be extra cautious not to drop a metal tool onto battery. It might spark or short circuit battery or other electrical part that may cause an explosion.
- Remove personal metal items such as rings, necklaces, watches, etc. Batteries can produce a short-circuit current high enough to weld such items causing a severe burn.

- NEVER charge a frozen battery. Thaw it out for safer and more efficient charging.

## 4. Installation

The AC line, to which the charger is to be connected, must be capable of supplying 10 amperes to this charger.

 **CAUTION: TO REDUCE THE RISK OF FIRE, USE THIS CHARGER ONLY ON CIRCUITS PROVIDED WITH A MAXIMUM OF 20 AMPERE BRANCH CIRCUIT PROTECTION (CIRCUIT BREAKER OR FUSE), IN ACCORDANCE WITH THE NATIONAL ELECTRICAL CODE, ANSI/NFPA 70, AND ALL LOCAL CODES AND ORDINANCES.**

The use of an extension cord with the charger should be avoided. The use of an improper extension cord could result in a risk of a fire or electric shock. If an extension cord must be used, it must be UL and/or CSA approved. Locate all cords so that they will not be stepped on, tripped over or otherwise subjected to damage or stress. Extension cord must be properly wired and in good electrical condition, and large enough for the AC rating of charger as specified in this TABLE:

RECOMMENDED MINIMUM AWG SIZE FOR EXTENSION CORDS FOR BATTERY CHARGERS				
Length of cord (feet):	25	50	100	150
AWG size of cord:	12	12	10	8

Provide adequate ventilation for the batteries and charger. The convection-cooled design requires an unobstructed flow of cooling air for proper operation. Keep all charger ventilation openings at least two inches (2") (5cm) away from walls and other objects. Do not allow clothing, blankets, or other material to cover the charger.

 **WARNING: CHARGERS CAN IGNITE FLAMMABLE MATERIALS AND VAPORS. DO NOT USE NEAR FUELS, GRAIN DUST, SOLVENTS, OR OTHER FLAMMABLES.**

 **WARNING: TO REDUCE THE RISK OF AN ELECTRIC SHOCK, KEEP THE CHARGER DRY. DO NOT EXPOSE IT TO RAIN. FOR STORAGE, KEEP THE CHARGER IN A BUILDING.**

## 5. Grounding Instructions

This battery charger must be grounded to reduce the risk of electric shock. This charger is equipped with an AC cord set having an equipment-grounding conductor. This AC cord set must be connected to an appropriate receptacle that is properly installed and grounded in accordance with the National Electrical Code and all local codes and ordinances.



**WARNING: IMPROPER CONNECTION OF THE EQUIPMENT-GROUNDING CONDUCTOR CAN RESULT IN A RISK OF AN ELECTRIC SHOCK.**

The conductor with insulation having an outer surface that is green, with or without yellow stripe(s), is the equipment-grounding conductor. If repair or replacement of the charger's AC cord set is necessary, refer to a qualified service agent, and do not connect the equipment-grounding connector to a live terminal.

## 6. Preparing to Charge

The instructions printed on the charger are for daily reference. The charger is factory preset to charge using one of four operating MODES. Each mode is set to charge a particular Battery Pack as listed:

Mode 1:	36V 'US Battery' made Battery
Mode 2:	Trojan T108 Battery
Mode 3:	Trojan T105 Battery
Mode 4:	Exide Battery

Upon connection to Battery Pack, all five L.E.D.s flash on, then off, up to 4 times. The charger is communicating the Mode Setting to you. Simply count the number of times you see all five L.E.D.s turn on, and off. This MODE is preset at the factory.





**WARNING: ENSURE THE CHARGER IS CORRECTLY MATCHED TO THE BATTERY PACK. DAMAGE TO THE CHARGER AND BATTERIES, OR PERSONAL OR PROPERTY DAMAGE MAY RESULT IF THIS CHARGER IS USED ON THE WRONG BATTERY TYPE.**

6.1 Be sure area around battery is well ventilated while battery is being charged. Gas can be forcefully blown away using a non-metallic material like cardboard.



**WARNING: TO REDUCE THE RISK OF AN ELECTRIC SHOCK, CONNECT ONLY TO A PROPERLY GROUNDED, SINGLE-PHASE (3-WIRE) OUTLET. ALSO, REFER TO GROUNDING INSTRUCTIONS.**

 DANGER: RISK OF ELECTRIC SHOCK! DO NOT TOUCH ANY UNINSULATED PARTS OF THE CHARGER OUTPUT CONNECTOR, BATTERY CONNECTOR, OR BATTERY TERMINALS.

 DANGER: VISUALLY AND MANUALLY INSPECT TO VERIFY THAT THE DC OUTPUT CORD SET, PLUG AND BATTERY CHARGING RECEPTACLE ARE IN GOOD WORKING CONDITION BEFORE EACH AND EVERY USE AND DO NOT USE THE CHARGER IF:

- The DC charging receptacle does not grip the DC cord set plug tightly, is loose or does not make a good electrical connection.
- The DC cord set plug or charging receptacle feel hotter than normal.
- The DC cord set plug blades or charging receptacle contacts are bent, corroded or are dark or bluish in appearance.
- The DC cord set plug, cords, receptacle or equipment charging wiring are cut, worn, broken or have any exposed conductors.
- The DC cord set plug, cords, charger or receptacles are damaged or distressed in any way.

Using the charger with any of the above symptoms could result in a fire, property damage or personal injury.

Have your distributor, dealer or other qualified service agent, repair or replace worn or damaged parts immediately. **Repairs should not be attempted by people who are not qualified.**

6.2 Connect the DC cord set plug to the charging receptacle by grasping the plug body or handle and pushing the plug straight into the receptacle. Then connect charger's AC cord set to AC power. The charger will start automatically in approximately three (3) seconds.

 WARNING: DO NOT DISCONNECT THE DC CORD SET PLUG FROM THE CHARGING RECEPTACLE WHEN THE CHARGER IS ON. THE RESULTING ARCING AND BURNING OF THE PLUG AND RECEPTACLE COULD CAUSE THE BATTERIES TO EXPLODE. IF THE CHARGER MUST BE STOPPED, FIRST DISCONNECT THE AC POWER SUPPLY CORD FROM ITS AC OUTLET, AND THEN DISCONNECT THE CHARGER DC CORD SET PLUG FROM THE CHARGING RECEPTACLE.

 **WARNING: WHENEVER REMOVING AC OR DC CORD SET PLUGS FROM RECEPTACLES, PULL FROM THE PLUGS' BODY AND NOT FROM THEIR RESPECTIVE CORDS.**

## **7. 5-STAGE CHARGE**

- If the charger's AC cord set is first connected to AC power, while the charger's DC cord set is left unconnected, the L.E.D.s will remain off and no power is delivered to the charger's internal circuitry due to an internal relay, which remains in the 'OFF' state.
- If the charger's DC cord set is first plugged to the charging receptacle, while the AC cord set is left unconnected, approximately 3 seconds after connection, (and assuming the use of the charger set to MODE-2), all 5 charger L.E.D.s will flash on and off, twice, and then all L.E.D.s will turn off. The charger will remain in this idle mode, with all L.E.D.s off, until AC power is connected.
- Immediately, upon connection of the charger's AC cord set to AC power, a 'click' can be heard. This is the charger's internal relay clicking 'ON'. The 'Power On' L.E.D. will illuminate to indicate that AC power is applied, and the charger will then commence charging as described.

## **DPI'S 5-Stage Charging Process works as follows:**

### **7.1. STAGE ONE - PRE-QUALIFICATION TEST**

- 7.1.1. Yellow, Light Emitting Diode (L.E.D.), flashes on and off SLOWLY at a rate of once every 2 seconds during this stage. This stage applies tests to the battery pack. Further charging is prohibited if the charger discovers a fault such as connection to a 72V battery pack or reversed battery connections. Refer to Section 9 - 'Troubleshooting' for understanding faults.
- 7.1.2. The duration of this stage is dependent on the condition of your battery - approximately 45 seconds under average circumstances, but if your battery pack was allowed to severely discharge to less than 42v, then this stage can last as long as 5hrs.

### **7.2. STAGE TWO - CONSTANT CURRENT CHARGE (Bulk Charge)**

- 7.2.1. Yellow L.E.D. illuminates continuously indicating that the charger is charging the battery at the full rated output.

### **7.3. STAGE THREE - CONSTANT VOLTAGE CHARGE (Absorption Charge)**

- 7.3.1. Yellow L.E.D. remains illuminated continuously, but the charger now regulates voltage and not current. While the charger maintains a constant voltage, the charge current gradually decreases.
- 7.3.2. When the charger has determined the battery pack has reached 80-90% capacity, the Yellow and Green L.E.D.s both illuminate.
- 7.3.3. This stage ends when the charge is replenished to 100% capacity.

### **7.4. STAGE FOUR - CHARGE COMPLETE (Standby)**

- 7.4.1. Green L.E.D. only, illuminates continuously. The charger will also disconnect itself from AC power, thereby saving energy and cost. While connected to the battery, the microprocessor remains active to monitor battery voltage and to keep a record of elapsed time. The charger's DC cord set can now be disconnected from the charging receptacle by grasping the plug body or handle and pulling the plug straight out of the receptacle.

### **7.5. RECYCLE CHARGE STAGE FIVE**

- 7.5.1. Only after the completion of Stage 4, and after 14 days of time has elapsed, AND if the battery voltage falls below 36Vdc, the charger will reset itself; thereby automatically initiating a new charge cycle routine and restoring battery to full capacity.
- If the charger is left connected to AC Power, and then the DC cord set plug is re-connected to another battery pack, the charger will restart a new charge cycle from the beginning (Stage 1).
- If, during any part of the 5-Stage Charge process, AC power should happen to be disconnected, the microprocessor will momentarily stop its program and wait for restoration of AC power. Thereafter, charging will resume from where it left off.
- If, while charging, the charger finds an abnormal charge condition, it will attempt to shutdown and indicate the 'Condition' by flashing one or all of its RED L.E.D.s. Refer to the 'Troubleshooting' section for a description of the Charge Error Condition, if you encounter a flashing RED L.E.D.

## 8. L.E.D. DISPLAY

Under normal charge circumstances, the L.E.D.s operate as follows:

- Power On (Red) Illuminates continuously when AC power is present. Refer to the section 'TROUBLESHOOTING' if Flashing.
- Abnormal Shutdown (Red) Normally not illuminated. Refer to 'TROUBLESHOOTING' if Flashing.
- Detection Error (Red) Normally not illuminated. Refer to 'TROUBLESHOOTING' if Flashing.
- Charging (Yellow) Charge Status Indicator – it flashes or illuminates during the 5-Stage Charge Process. Refer to Section 7.
- Charged (Green) Illuminates continuously during the 4<sup>th</sup> Stage of the Charge Process. Refer to Section 7.

 **CAUTION:** TO AVOID DAMAGE TO THE CHARGER CORDS, PLUGS, AND CHARGING RECEPTACLE, DO NOT PULL ON ANY OF THE CHARGER'S CORDS. DO NOT TWIST, ROCK, OR PULL THE PLUGS FROM THEIR MATING RECEPTACLES SIDEWAYS.

## 9. TROUBLESHOOTING GUIDE

To be able to troubleshoot safely and effectively, it is important to read this guide completely before beginning any tests.

 **WARNING:** DO NOT DISASSEMBLE THE CHARGER. TAKE IT TO A QUALIFIED SERVICE AGENT WHEN SERVICE OR REPAIR IS REQUIRED. INCORRECT REASSEMBLY MAY RESULT IN A RISK OF ELECTRIC SHOCK OR FIRE. THE FOLLOWING PROCEDURES ARE INTENDED ONLY TO DETERMINE IF A MALFUNCTION MAY EXIST IN THE CHARGER.

 **DANGER:** TO REDUCE THE RISK OF ELECTRIC SHOCK, ALWAYS DISCONNECT THE CHARGER'S AC CORD SET FROM AC POWER AND ITS DC CORD SET PLUG FROM BATTERIES BEFORE ATTEMPTING ANY MAINTENANCE OR CLEANING

 **WARNING: DO NOT OPERATE THE CHARGER IF IT IS MALFUNCTIONING. PERSONAL INJURY OR PROPERTY DAMAGE COULD RESULT.**

If any of the three red L.E.D.s flash, the charge cycle has terminated prematurely. An abnormal charging condition was detected and charging stopped due to a Charge Error Condition. Refer to the following Charge Error Table for a description of the possible failure or condition.

**CHARGE ERROR TABLE**  
Flashing L.E.D.s

<u>Condition</u>	<u>Power</u>	<u>Abnormal</u>	<u>Detection</u>
Battery Voltage High	Off	Off	Flash
Battery Polarity Reversed	Off	Flash	Off
Output Overload	Off	Flash	Flash
Charge Level Unbalanced	Flash	Off	Off
Excessive Charging Time	Flash	Off	Flash
Excessive Overload	Flash	Flash	Off
Excessive Discharged	Flash	Flash	Flash

- Battery Voltage High. Charger's DC cord set possibly connected to a battery pack with voltage higher than the output rating of the charger.
- Battery Polarity Reversed. Check output connector and ensure proper polarity. Remake connections.
- Output Overload. While charging, and, for example, under severe motor loading, charger may shut down. This error is not very likely to occur.
- Charge Level Unbalanced. Caused by unbalanced battery condition. Example: some batteries are at a much higher state of charge than others. This may require replacement of the batteries. Refer to the Equipment's Operators manual for instructions on servicing the battery pack.
- Excessive Charging Time. Occurs when charging took too long. Possible causes include: use of a battery load that is draining energy from the battery while the charger is trying to charge that same battery, aged or unbalanced battery conditions, etc.

- Excessive Overload. In the unlikely event that a heavy load is placed across the battery pack while the charger is trying to charge the battery, and the charger cannot keep up with supplying energy to both the battery and the load, then the battery voltage will decrease. Further charging is terminated.
- Excessive Discharged. This error is only generated by a condition found during the Pre-Qualification Test Stage. If a severely discharged battery pack did not charge up to 42v within 5 hrs, this error occurs.

## **TECHNICAL NOTES**

Do not charge more than one battery pack at a time. Battery pack characteristics differ and may cause the microprocessor to function improperly.

 **WARNING:** For your own protection, when using ANY 24,36,42,48v or other type of charger, always ensure that the batteries in your Battery Pack ARE ALL at the same state of charge, same condition, same size, and same rating. DO NOT MIX DIFFERING SIZES OR TYPES. Never use charger for any purpose contrary to its intended purpose of charging lead acid batteries in accordance with ALL instructions printed in this manual.

 **WARNING:** IF THE CHARGER'S AC OR DC OUTPUT PLUGS OR THEIR MATING RECEPTACLES ARE BROKEN, TWISTED, BENT OR LOOSE AND DOES NOT MAKE GOOD ELECTRICAL CONTACT, HAVE IT REPLACED BY A QUALIFIED SERVICE AGENT IMMEDIATELY. DO NOT USE THIS CHARGER IN THIS CONDITION AS FIRE OR PERSONAL INJURY CAN RESULT.

## **IF THE BUILDING AC LINE CIRCUIT BREAKER OR FUSE BLOWS**

This condition can be caused by a charger problem, a “weak” fuse or circuit breaker protecting the circuit or an overloaded circuit. If the building AC power fuse or circuit breaker blows, connect the charger to another outlet (on different circuits) in the building. If the charger operates properly on other circuits, have a qualified electrician inspect and test the original circuit. If the charger causes other fuses or circuit breakers (in the building) to blow, the charger should be tested for a problem.

# 10. Schematic Drawing

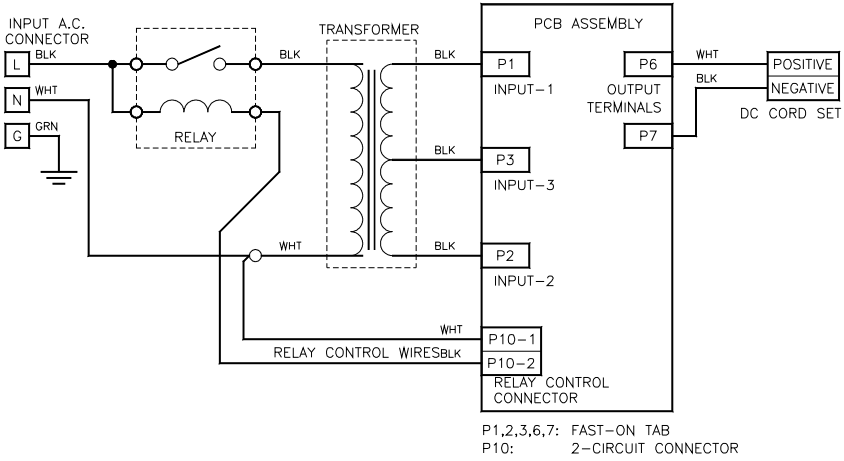

# 11. Parts List

The items listed below refer to the Exploded View Drawing, following the list. If replacement items are needed, please reference the P/N and Model.

ITEM	P/N	DESCRIPTION
1.	IPC021	AC Cord Set
2.	HDS009	AC Cord Set Strain Relief
3.	HDS056	Bumper Foot
4.	HDW069	Bumper Foot Screw
5.	HDS054	Transformer Standoff Tube
6.	LAB141	Front Panel Label
7.	HDW015	Heatsink To Case Screw
8.	HDS055	DC Cord Set Strain Relief
9.	OPC052	DC Cord Set
10.	HDW007	Transformer Mounting Nut
11.	HDW070	Transformer Mounting Bolt
12.	HDS057	Transformer Mounting Bushing
14.	RLY003	AC Input Relay
15.	HDW016	Relay Mounting Screw
16.	ENC049	Base Enclosure
21.	HDW003	Bumper Foot Nut
22.	PCM028	PCB/Microprocessor Assembly
24.	HDW072	Rivet Backup Washer
25.	LAB141	UL & Product I.D. Label
26.	HDL002	Handle
27.	HDW071	Handle Rivet
28.	ENC047	Cover Enclosure
29.	HDW041	Enclosure Screws
30.	XFR002	Transformer Assembly
31.	HDW011	Relay Mounting KEPS Nut

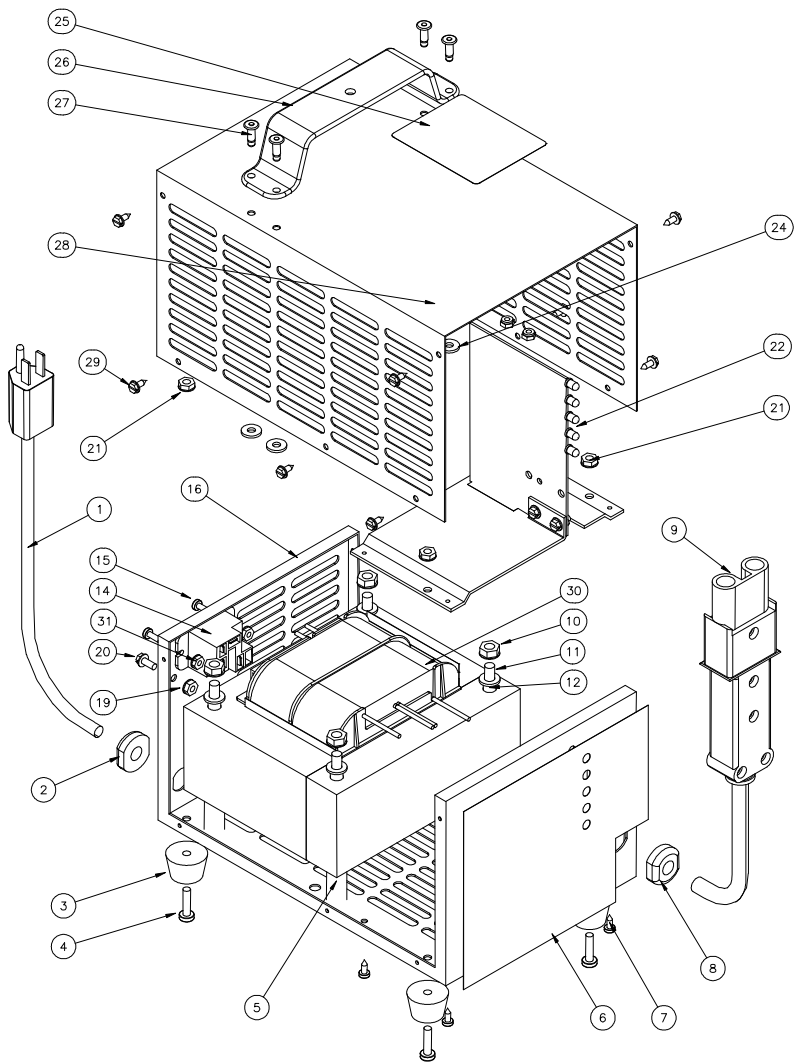

## **12. LIMITED WARRANTY**

Diversified Power International LLC (DPI) warrants exclusively to the original purchaser that this product will be replaced or repaired, at DPI's option, if it fails during the first 2 years after date of purchase due to a defect in material or workmanship. In order for a claim to be processed the product must be returned to DPI (i) with all transportation charges prepaid, (ii) accompanied by a acceptable proof of purchase, and with a Return Material Authorization (RMA) number, previously obtained from DPI, printed and clearly visible on the outside of the shipping container. This warranty does not apply if the product has been modified, abused, or damaged or improperly or negligently used, connected, maintained, or operated in any manner contrary to the instructions stated in this manual or affixed to the product's enclosure. Repair or replacement as provided under this warranty is the exclusive remedy of the purchaser, and the purchaser shall have no claim against DPI except for the breach of an express warranty stated herein. DPI shall not be liable for any incidental, consequential, or special damages for breach of any expressed or implied warranty. Except to the extent required by applicable law any implied warranty of merchantability or fitness for a particular purpose is limited in duration to the first two (2) years after the date of purchase. Some states do not allow the exclusion or limitation of incidental or consequential damages or allow limitations on how long an implied warranty lasts, so the above limitations or exclusion may not apply to you. This limited warranty gives you specific legal rights, and you may also have other rights which vary from state to state. APART FROM THE WARRANTIES SET FORTH ABOVE, DPI MAKES NO OTHER WARRANTY, EXPRESS OR IMPLIED, WITH RESPECT TO THE SUITABILITY OR MERCHANTABILITY OF THIS PRODUCT, THE FITNESS OR THIS PRODUCT FOR ANY SPECIFIC USE OR PURPOSE, OR ANY OTHER MATTER PERTAINING TO THIS PRODUCT.

Return information:

DIVERSIFIED POWER INTERNATIONAL LLC

414 CENTURY COURT

PINEY FLATS, TN 37686, U.S.A.

423 538-9002

RMA # \_\_\_\_\_

For further information, product updates, technical information, or general inquiries, also, please visit our web site at: